



KD Pocket Door Frame

(Can be used for Residential)

for 1" to 1 3/8" Thick Door - 2" x 4" Stud Wall

(For 1 3/4" use KD134KIT) (For Joining 2 doors use 751 Mullion Connector)

Commercial Grade Pocket Frame Instructions

1

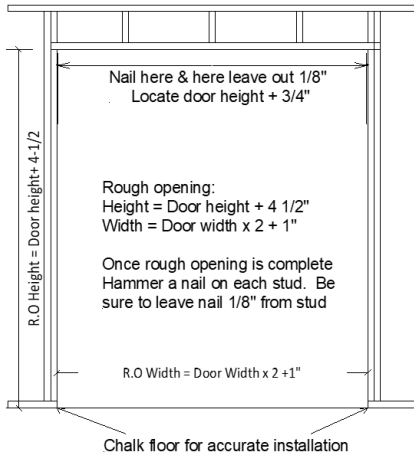

Header must be Level and studs should be Plumb. Hammer a nail (leave 1/8" sticking out) on centerline of each stud. Pocket Header will rest on these.

Chalk floor even with Studs

2

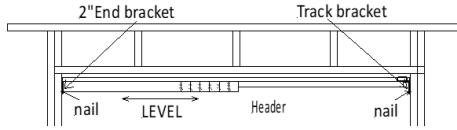

Slide the slot on the Header End bracket and Track bracket over the nails set from step 1

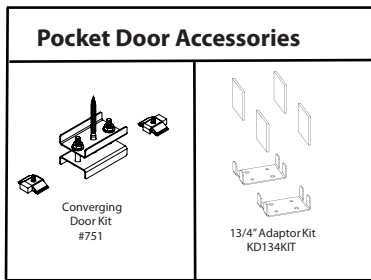

3

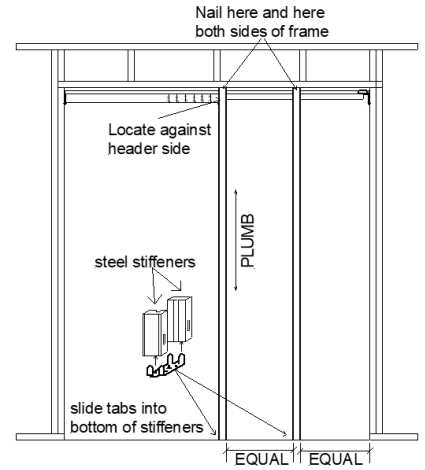

Insert floor bracket into bottom of steel stiffeners, see above. Butt stiffeners to header nailing strip, then nail into place (Wood side of stiffeners facing out)

Attaching Door & Hardware (door by others)

4

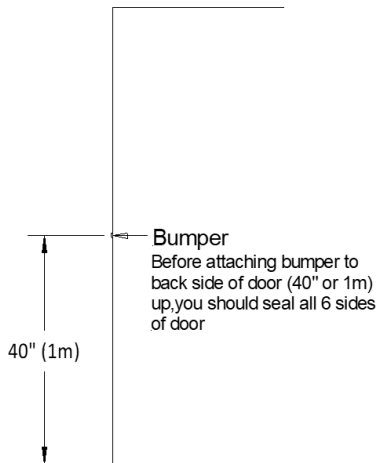

5

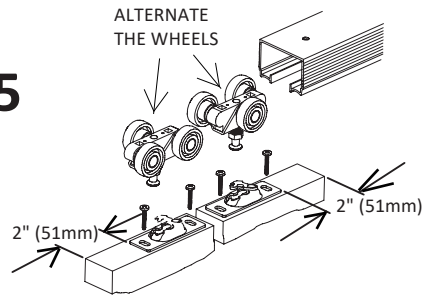

Attach door plates 2" from each edge on top of door with the lock tabs on the same side. Alternate wheels in track. Lift door onto bolts, then lock the tab in place.

6

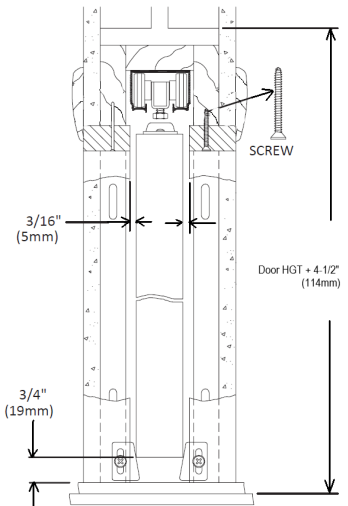

Mount split guides to finish vertical stops so that door is centered and not binding

Cutting Instructions for Pocket Door Frame Header

Cutting Instructions for pocket door frame header: The head is stamped for cutting to shorter lengths. Cutting instructions are below.

To assure accuracy, use a tape measure

2/10 = 34" (86cm) 2/8 = 32" (81cm) 2/6 = 30" (76cm) 2/4 = 28" (71cm) 2/2 = 26" (66cm) 2/0 = 24" (61cm)

A

Remove Adjustable end bracket.



B

Cut through WOOD part of header only, on proper door size mark.



C

Turn Header on side and cut 3/4" (19mm) Head Trim Board ONLY at proper mark. Remove cut off end and discard.



D

Turn Header over and cut Track 1-1/4" (32MM) shorter than wood header

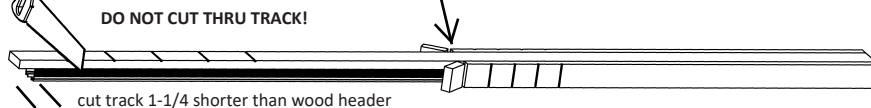

E

Replace Adjustable End Bracket on new cut end of header.

