

*Following steps are for soft open. Skip steps 1-3 if new installation.*

- 1** IF FRAME is already installed, disconnect Hangers from Door Plates and remove door. Remove both Hangers from track-Remove Door Plates from door.
- 2** CUT ACCESS HOLE by measuring door width and door height, then on pocket wall, measure over door width minus 2" (51mm) and door height minus 2" (51mm). Then from that mark, measure down 8" (203mm) and over toward opening 8" (203mm). Cut square in wall to access track.

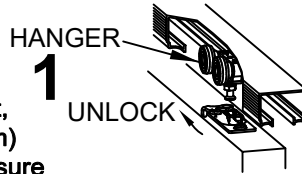

- 3** CHECK to make sure all track screws are flat against track. DISASSEMBLE ACTUATOR ARM, (with backside of arm facing pocket), insert arm, bumper and lock nut into track and reassemble. Slide assembly into pocket until backside of Actuator Arm is 2-1/4" (57mm) plus the finish Split Jamb thickness from the rough stud. **Example 2-1/4" (57mm) + 7/16" (11mm) Finish Jamb = 2-11/16" (68mm).** Hand tighten Actuator Arm (do not use power drill). Check to make sure Arm remains straight in track.

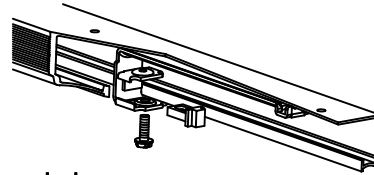

- 4** IF NEW INSTALLATION insert Actuator Arm as shown below.

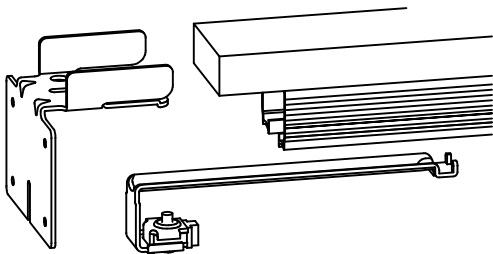

Remove Bracket, Install Actuator Arm, Reattach Bracket.

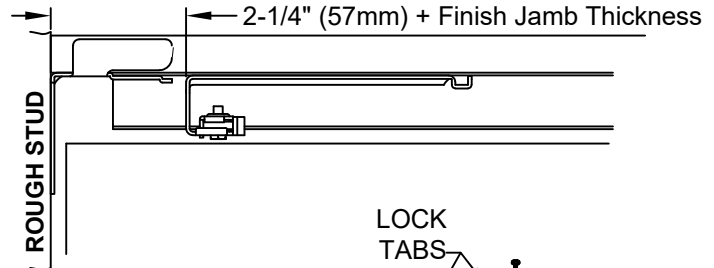

- 5** ATTACH 100 Door Plates 2-3/4" (70mm) from door edge.

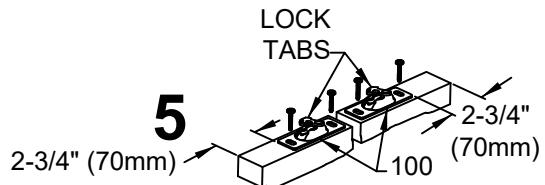

- 6** Engage Soft Close Dampener by pushing Dampener trigger toward 3 wheel roller. ***This step is very important. DAMPENER MUST BE ENGAGED*** or soft close will not work, 1000 Soft Close Dampener may be **DAMAGED** if installed incorrectly. Door will have to be removed and installation of 1000 will have to begin again.

**IMPORTANT**  
**MUST BE ENGAGED**

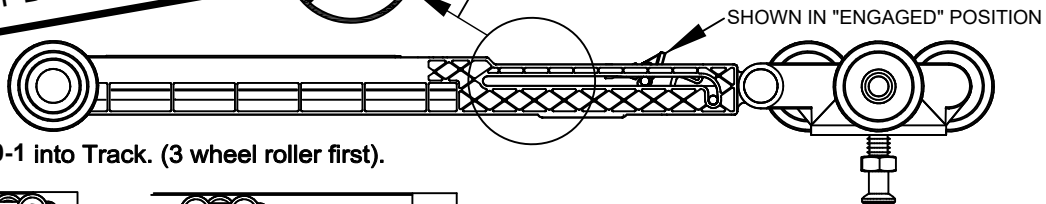
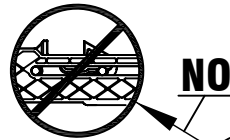

- 7** INSERT 1000-1 into Track. (3 wheel roller first).

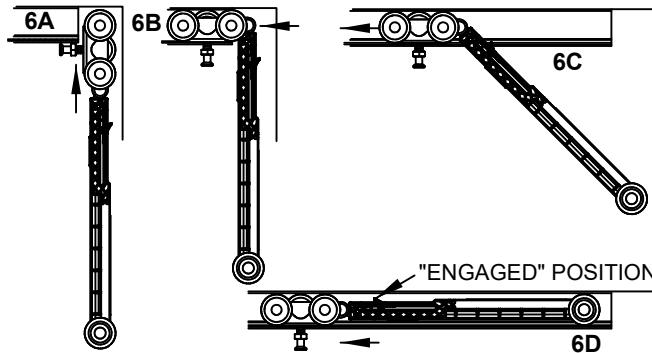

- 8** INSERT 1000 Ball Bearing Hanger Wheel assembly into Track.

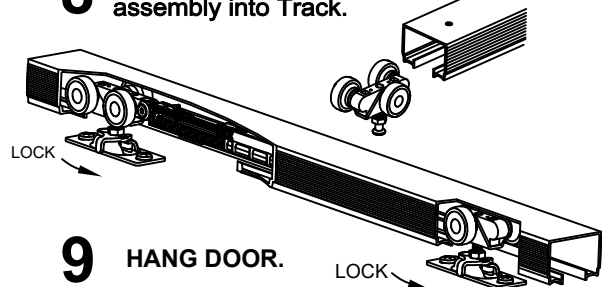

- 10** SLOWLY slide door into pocket, checking to make sure door opens flush with Split Jamb, if not, slide door out of pocket and readjust Actuator Arm. Slowly open door again, checking to make sure soft close is working properly. Once confirmed, begin using door normally.

- 11** PATCH the wall.